

THE WAIT
IS OVER

CS 8100 3D



3D imaging is now **available for everyone**

COMPLEXITY IS NO LONGER THE STANDARD

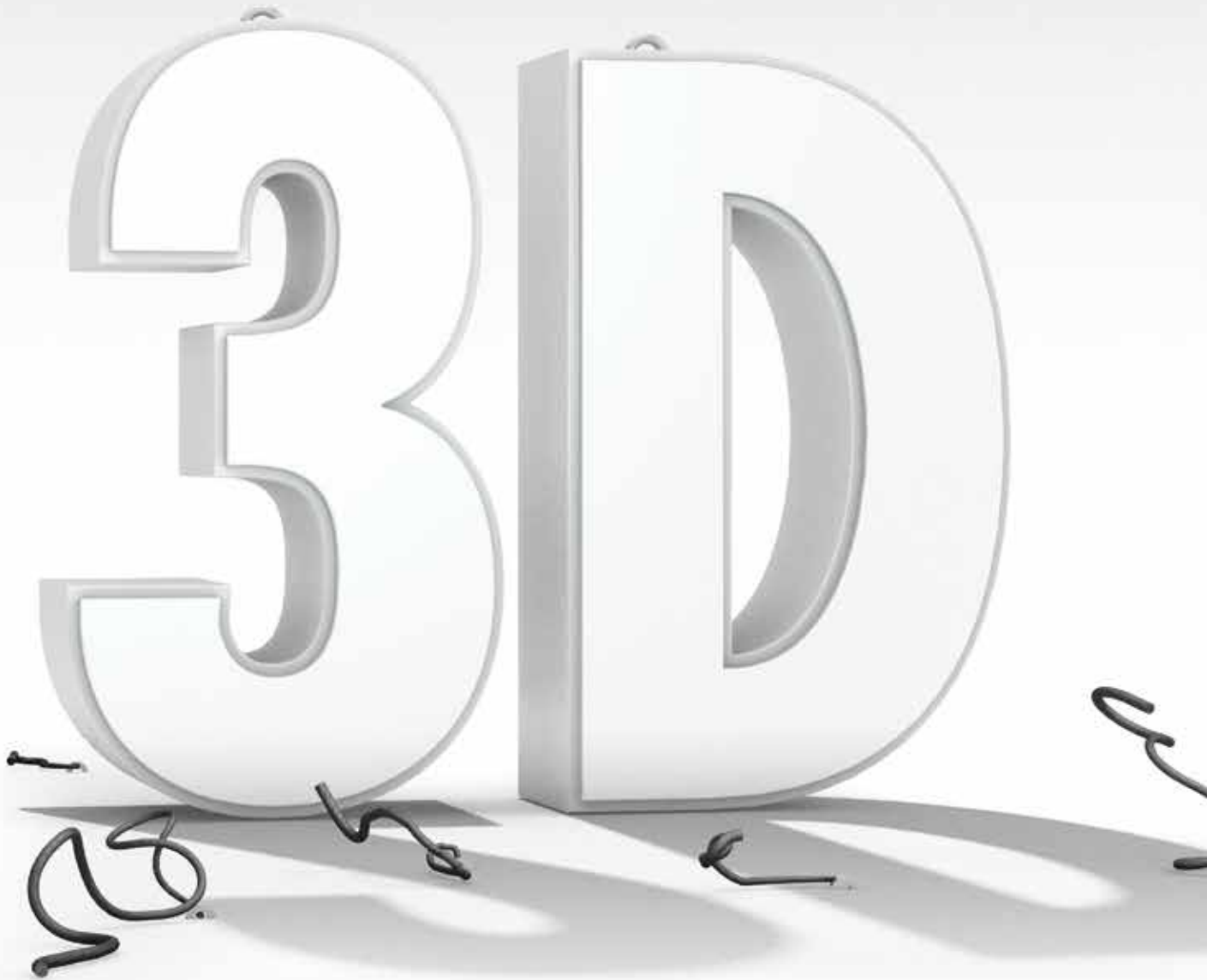

WE'RE REMOVING THE OBSTACLES THAT TRADITIONALLY COME WITH MOVING TO 2D/3D IMAGING

Despite previous advances in 2D/3D technology, the truth is that the challenges often outweighed the benefits. Many did not see the need for such sophisticated technology. They feared they wouldn't use it, believed it to be too complex, thought it was too expensive or simply said: "not today."

They were waiting for a 2D/3D system that was more relevant to their everyday work, that was plug-and-play and that was a strong yet affordable investment for their practice.

Today that wait is over.



NOW THERE ARE MANY REASONS TO MOVE TO 2D/3D IMAGING

Now it's possible to experience nothing but benefits when moving to 2D/3D imaging. And the more benefits you experience, the better care you are able to provide.

TRUE-TO-LIFE VISION – You see your patients in 3D, so it only makes sense to see their teeth that way too. You can see any anatomical situation from any angle, without distortion, overlap or misinterpretation.

EXPERT DIAGNOSES – Specialized technology is no longer restricted to the specialized few. 2D/3D technology enables both specialists and general practitioners to diagnose with complete confidence and ease.

GREATER CAPABILITIES – The benefits of 3D imaging go beyond implants. 3D can be used in everything from everyday procedures to molar removal, pre-surgical planning and more.

BETTER COMMUNICATION – Patients want to be better informed. And with clear 3D images, it's easier for patients to see, understand and accept their diagnoses.

FAST APPOINTMENTS – Let's face it: patients aren't patient. With 2D/3D examinations, you can aim to reduce patient waiting time and the number of appointments.

QUICK PAYOFF – At an affordable price, 2D/3D functionality adds to your services and capabilities, providing a quick return on investment for practices large and small.

INTRODUCING THE CS 8100 3D



THE SIMPLE AND AFFORDABLE 2D/3D IMAGING SYSTEM YOU'VE BEEN WAITING FOR IS HERE

3D imaging is not only the future of dentistry, it is the new standard of care – and never before has it been so accessible as it is now. With the intuitive CS 8100 3D extraoral imaging system, your patients will benefit from more precise treatment plans that improve care and reduce appointments, and you'll appreciate a system that simply gives you everything you need with a quick return on your investment.

KEY BENEFITS

- Selectable fields of view and versatile programs
- Highly detailed images with up to 75 μm resolution
- Intuitive and comfortable patient placement
- Fast acquisition and low dose
- The new standard of care, now even more affordable

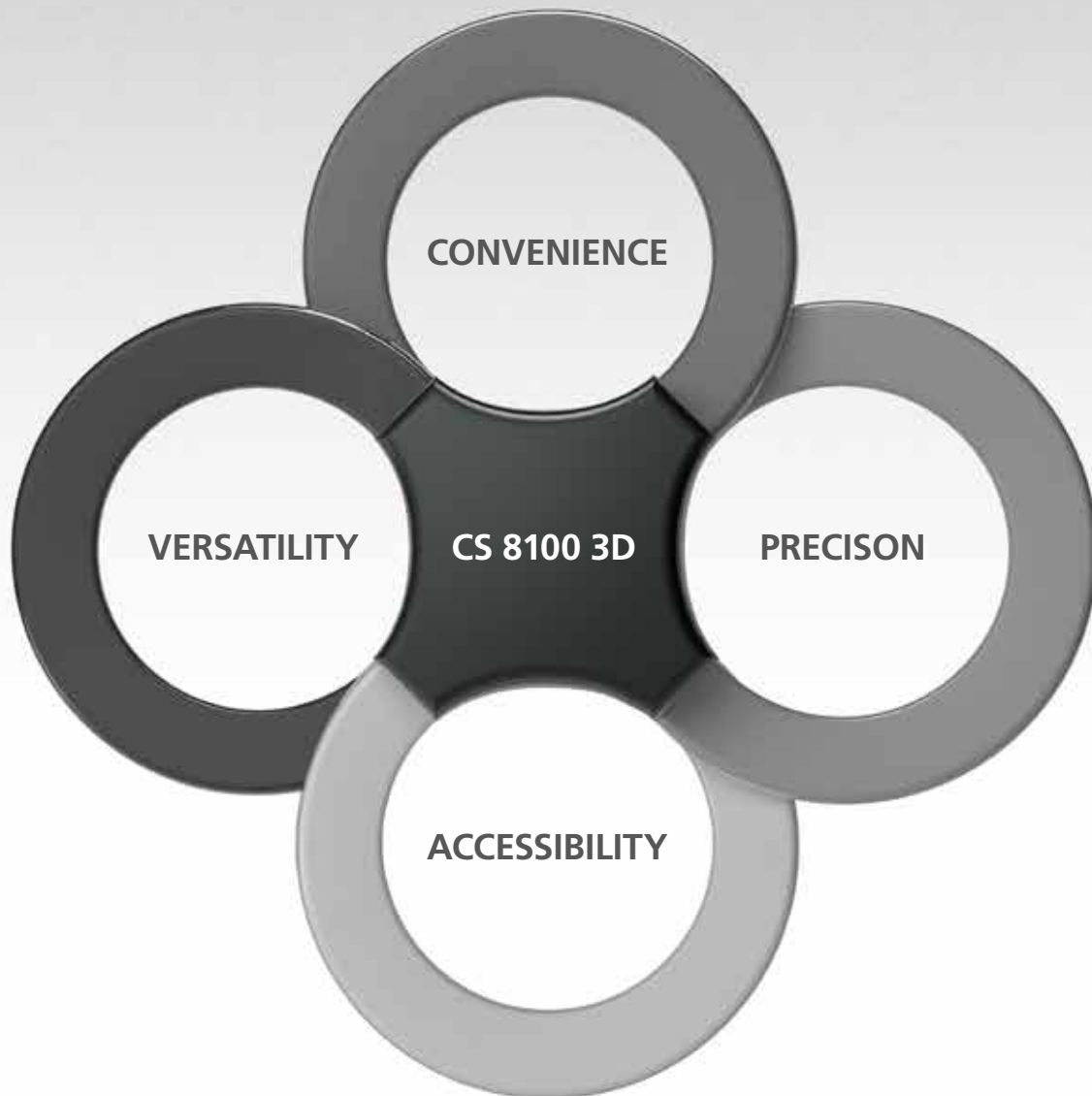

A MULTI-BENEFIT, MULTI-FUNCTIONAL X-RAY SYSTEM

The CS 8100 3D puts the advantages of 2D and 3D imaging in the reach of the general practitioner, periodontist, endodontist and other specialists of practices large and small. Every single feature has been revamped and redefined to remove the obstacles of moving to 2D/3D imaging, making it more powerful, user-friendly and affordable.

This system offers your practice four main benefits: the versatility of a multi-functional system with the potential to expand your services; the convenience of seamless exams for both dentists and patients with complexity removed; the high image precision you require to meet all dental needs for a more accurate diagnosis; and great accessibility in terms of affordability, sharing and ease of integration.



VERSATILE

VERSATILE PROCEDURES

2D PANORAMIC



SEE MORE, KNOW MORE AND DO MORE IN YOUR PRACTICE

Dental professionals are looking for flexible imaging equipment that can cover all their diagnostic needs – an investment that generates a strong return. That's why, the versatile, multi-functional CS 8100 3D covers nearly all routine and more advanced needs, making it ideal for a great variety of dental

procedures. Now you can cost-effectively perform the essential first step in 2D panoramic, investigate in depth with powerful 3D imaging, or effortlessly obtain digital 3D models. This single system enables you to do and offer even more in your practice, improving your overall level of patient care.



CAD/CAM COMPATIBLE

3D IMAGING

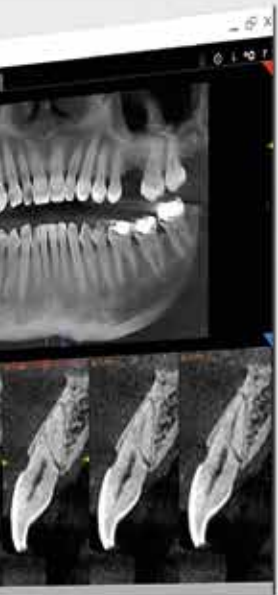

DIGITAL 3D MODELS



FROM PHYSICAL MODEL TO DIGITAL MODEL IN 3D

The ingenious special programs of the CS 8100 3D allow you to obtain high precision digital 3D models by simply scanning patient impressions, radiographic guides or plaster models. This scanned data even enables you to perform CAD/CAM procedures in your practice with our

integrated CS Solutions restorative portfolio. The data can also be exported in STL format to be used with third-party design software.



VERSATILE

VERSATILE APPLICATIONS

SUPERB 2D IMAGING FOR ESSENTIAL ROUTINE REVIEW

Due to its low dose and simplicity, 2D panoramic imaging remains an indispensable tool for the majority of dental practices. And whether you are a general practitioner or a specialist, the CS 8100 3D's complete range of programs

covers all your routine panoramic needs. Four patient morphologies and three jaw shapes help you capture the desired area effortlessly. So, whatever the program, the result is superb panoramic images in just a few seconds.

STANDARD PANORAMIC



PEDIATRIC PANORAMIC



SEGMENTED PANORAMIC



LATERAL TMJ (2 OR 4 VIEWS)



MAXILLARY SINUS



SEGMENTED BITEWING



POWERFUL 3D IMAGING FOR AN ENHANCED VIEW FROM EVERY ANGLE

3D imaging can enhance the standard of care for endodontics, implants, oral surgery and daily procedures of the general practice. Selectable fields of view give you what you need for a faster, more accurate, task-specific diagnosis. You are

able to obtain your desired image while controlling image size, resolution, region of interest and dose. In terms of dose, the safety of the patient is always the highest priority.

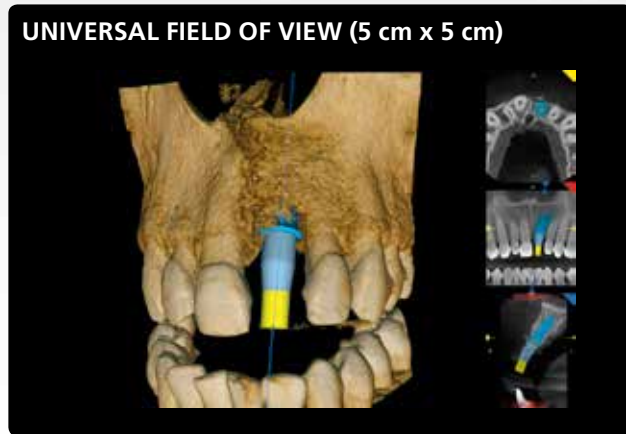

Universal field of view (5 cm x 5 cm) is preferred as the ideal compromise between image size and dose without capturing unnecessary information (i.e. local pathology, single implant, endodontic)

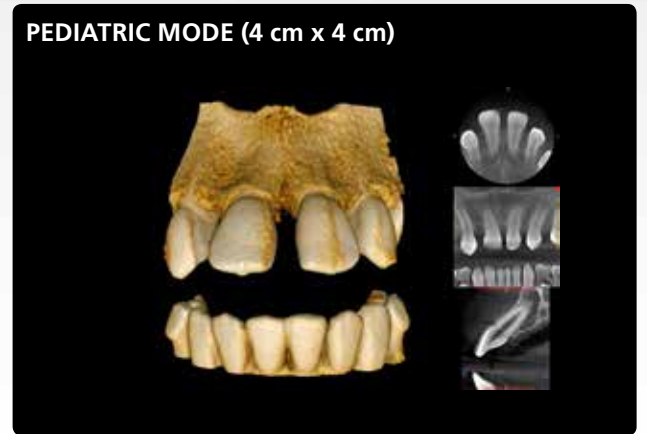

Pediatric mode (4 cm x 4 cm) is used for pediatric or follow-up exams with approximately 50% less dose than 5 cm x 5 cm exams

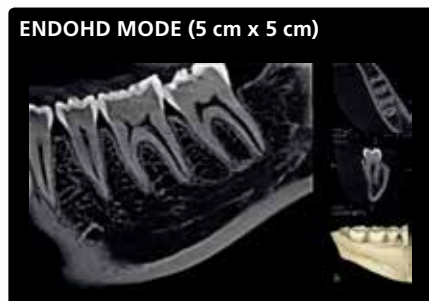

EndoHD mode (5 cm x 5 cm) delivers extremely high resolution scans (75 µm) in order to see the smallest details of root and canal morphology

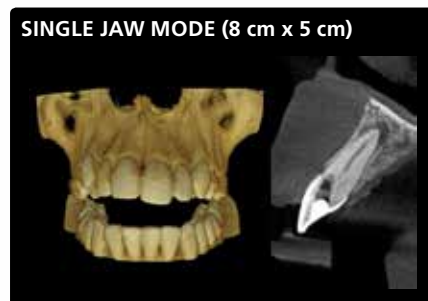

Single jaw mode (8 cm x 5 cm) captures one arch and is ideal for cases involving a larger area (i.e. implant planning with surgical guide creation, oral surgery, larger disorders)

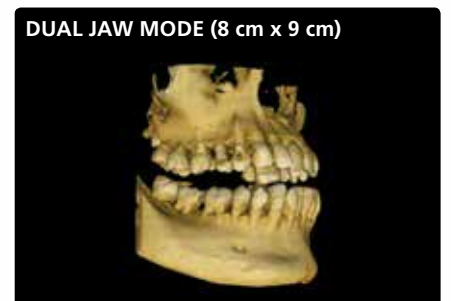

Dual jaw mode (8 cm x 9 cm) captures both dental arches and is ideal for cases involving both the maxilla and the mandible (i.e. implant planning with surgical guide creation, oral surgery, larger disorders)

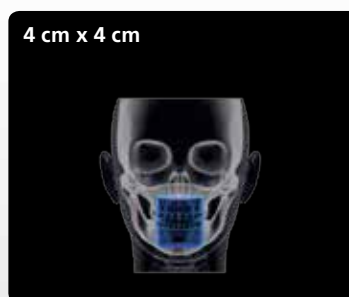

Selectable fields of view enable you to see more from every angle.



CONVENIENCE

CONVENIENT EXAMINATIONS



Clear letter landmarks on the bite block that match the corresponding software interface for intuitive, more accurate positioning and fewer retakes.

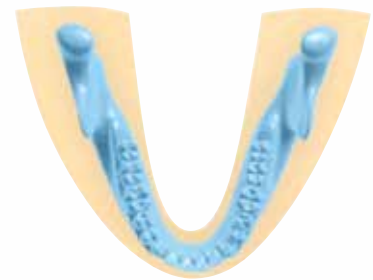
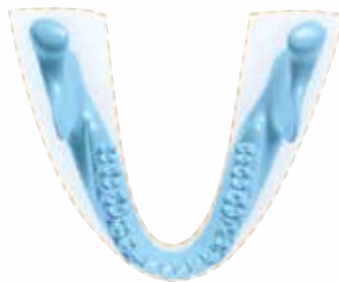

A wider focal trough minimizes retakes and increases tolerance to imperfect positioning.

SIMPLE, GUIDED POSITIONING FOR DENTISTS

The intuitiveness of the CS 8100 3D makes positioning and image capture comfortable for both new and more experienced users alike.

Clear instructions on an easy-to-use interface and a computer-controlled system with pre-set programs simplify set-up and workflow. For 2D panoramic imaging, three anatomical programs adapt to the patient's jaw morphology, and increased thickness and width of the focal trough improve tolerance to imperfect positioning and challenging anatomy.

Plus, for 3D imaging, letter landmarks on the smart bite block that align with the system interface help facilitate proper patient placement and increase accuracy. This makes the use of a laser beam completely obsolete and reduces the risk of retakes. Moreover, the same sensor is used for all modalities, eliminating the need to change it between exams.



Open, face-to-face positioning increases comfort and puts patients more at ease.



Adjustable for patients of all sizes and wheelchair accessible.



QUICK, SEAMLESS EXAMS FOR PATIENTS

A new rigid, yet comfortable, patient support with integrated handgrips helps align patients throughout the exam for smooth and successful capture. The open design with face-to-face positioning reduces the feeling of confinement and puts patients more at ease. Motorized silent movement also allows you to comfortably adjust the unit to patients of all sizes, and is wheelchair accessible.

Fast scanning times (as little as 7 seconds) reduce patient movement for optimum image quality and fewer retakes. The speed of the exam and accuracy of positioning, in turn, limit patient exposure by an estimated 60-70% compared to conventional CT systems, which allows for safer examinations.

Fast scanning
from 7 seconds.





PRECISION

PRECISION IMAGING



4T CMOS sensor for extremely sharp images and contrasted details.

HIGHLY DETAILED AND CONTRASTED IMAGES

High precision images with the latest technology give you a more accurate view of your patients' dental anatomy for improved diagnostics and treatment. And the CS 8100 3D incorporates all the technologies you need for the best possible results. It combines a high frequency generator, new image processor and vibration-free motion system for smooth, quiet and error-free capture. It also features our very own 4T CMOS sensor that results in sharp images and highly contrasted details with up to 75 μm of resolution.

With one click, you can even enhance image sharpness and contrast using our artifact-free filters. And 3D images give you a more precise overview of the problem area, allowing you to see your patients from every angle with one-to-one accuracy without overlap or distortion. Measurements and anatomical relationships are also more precise, which reduces the risk of mistakes or misinterpretation.



Intuitive yet powerful 2D imaging software
and comprehensive CS 3D Imaging software.

IMAGE PROCESSING AND REVIEW WITHOUT ALL THE COMPLEXITY

The CS 8100 3D's effective and straightforward tools have been designed to remove the complexity that traditionally comes with processing 2D panoramic and 3D images.

Our intuitive, yet powerful, 2D imaging software helps you analyze images quickly with user-friendly processing tools. Pre-set programs also minimize setup and clicks to optimize image processing and review. It serves as the control panel for all Carestream Dental systems and can be used as a standalone program or integrated with your practice management program.

What's more, our comprehensive and extremely simple CS 3D Imaging software makes images very easy to review. It utilizes the latest processing algorithms to create clear, easy-to-diagnose images. A 3D rendering view and slice-by-slice views are displayed simultaneously. From day one, you are able to review images, use implant planning and library functions, apply measurements and annotation tools, and share results with both patients and colleagues.

PRACTICE ACCESSIBILITY



Easy sharing via email, CD/DVD, USB flash drive, lightweight screen captures or print.

SIMPLE INFORMATION SHARING AND COMMUNICATION

The CS 8100 3D allows you to access images from any networked PC in the practice via Ethernet connection. Images can be shared through email, CD/DVD, USB flash drive or lightweight screen captures with easy printing options. Both the 2D viewer and the entire 3D software enable free and simple sharing with colleagues, labs and insurance companies. They also improve referrals or case collaboration.

Additionally, a “true-to-life” 3D rendering view enhances communication with patients. It makes it easier for patients to understand the diagnosis, which leads to increased treatment acceptance.



Thin and lightweight, compact and durable aluminum body.



MOST COMPACT
UNIT



EASILY INTEGRATES INTO YOUR PRACTICE

Equipped with advanced technology, the thin aluminum body of the CS 8100 3D is compact and fits nearly anywhere in your practice. However, don't let its size fool you – it may be extremely lightweight but it is also incredibly strong and durable.

This system can be easily installed by your local dealer, so that you can start working right away. It integrates seamlessly

into your practice and offers a minimal learning curve. The reliability of this system also makes it easy to maintain for long-life performance and reduced or eliminated service costs. And when the latest in dentistry is now this affordable, ask yourself: how is this not the right solution for your practice?

TECHNICAL SPECIFICATIONS

Tube voltage	60 - 90 kV
Tube current	2 - 15 mA
Frequency	140 kHz
Tube focal spot (IEC 60336)	0.7 mm (0.03 in.) with X-ray tube OPX110S or 0.6 mm (0.02 in.) with X-ray tube D-067
Input voltage (AC)	100-240 V - 50/60 Hz
Unit dimensions	330 (L) x 894 (D) x 1596 (H) mm 13 (L) x 35.18 (D) x 62.83 (H) in.
Minimum required space	1200 (L) x 1400 (D) x 2400 (H) mm 42.24 (L) x 55.11 (D) x 94.48 (H) in.
Weight	92 kg (202 lb 13 oz)
PANORAMIC MODALITY	
Sensor technology	CMOS
Image field	6.4 x 140 mm (Adult) – 6.4 x 120 mm (Pediatric)
Gray scale	16384 - 14 bits
Magnification	1.2 (± 10%)
Radiological exam options	Full panoramic, segmented panoramic, maxillary sinus, LA TMJ x 2, LA TMJ x 4, segmented bitewing
Exposure mode	4 patient sizes (child, small adult, medium adult, large adult) 3 dental arch morphologies (normal, square, sharp)
Exposure time	1.98 to 14 seconds
3D MODALITY	
Technology	Dental Volumetric Reconstruction (DVR)
Sensor technology	CMOS
Volume Field Of View diameter x height (cm)	4 x 4 / 5 x 5 / 8 x 5 / 8 x 8 / 8 x 9 cm* (*8 x 9 not available in Canada)
Radiological exams	Full, upper or lower jaw - Full, upper or lower molar - Occlusion - Teeth
Gray scale	16384 -14 bits
Voxel size (µm)	75 µm minimum
Exposure time	7 to 15 sec.

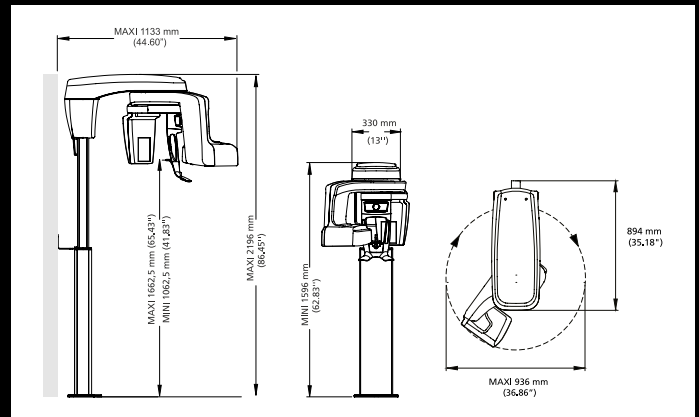

SUPPORT YOU CAN COUNT ON

Our registered dealers and service providers are certified in quality installation and support, and many services can even be performed remotely, including: configuration, diagnosis, repair, calibration and software updates. This helps keep your service costs and downtime to a minimum – and your practice productivity at the absolute maximum.

LET'S REDEFINE EXPERTISE

The CS 8100 3D is just one way we redefine imaging. Discover more at carestreamdental.com or or call 800.944.6365.